



Wiha ESD tools.

Wiha makes it possible: The right range for your ESD application.



EPA

Drive

	Slotted	Phillips PH	Pozidriv PZ	TORX®	TORX® Tamper Resistant	TORX PLUS®	For internal hex screws	For hex nuts	Tri-Wing®	Torq-Set®	
Wiha SoftFinish® ESD	265-266	265-266	265	266							
Wiha SoftFinish® ESD Stubby	265	265	265								
Wiha Precision ESD	268, 270	268, 270	268	269, 270		269	268, 270	268, 270			
Wiha Ceramic	271	271									
Wiha SYSTEM 6 ESD	273-274	273-274	273	273	273		273-274		274	274	
Wiha SYSTEM 4 ESD	276-277	276-277	276	276-277			276-277	277			
Wiha Torque ESD torque range	279-280	279-280	279-280	279-280							

ESD assortment

Wiha ESD tools.

For use on electrostatically sensitive components. 262 – 263



Wiha SoftFinish® ESD. 264 – 266



Wiha SoftFinish® ESD Stubby. 265



Wiha Precision ESD.
The static dissipative precision screwdriver. 267 – 270



Wiha Ceramic.
The non-static adjustment tool for clean rooms. 271



Wiha SYSTEM 6 ESD.
The compact allrounder. 272 – 274



Wiha SYSTEM 4 ESD.
Ideal for precision work. 275 – 277



Wiha Torque ESD torque range.
Precise and high repeat accuracy. 278 – 280



Wiha ESD bit holder. 281



Wiha Professional ESD.
Precise in every detail. 282 – 285



Wiha Professional ESD.
For high standards when it comes to precision and safety. 286 – 289



Wiha dialMax ESD.
Dial calliper. 290



Wiha ESD application sets.
The right tool for any application. 291



Wiha ESD tools.

For use on electrostatically sensitive components.



Wiha ESD tools.

The most serious danger when working with electronic components is posed by electrostatic discharges. Because even with low discharge levels not perceived by people, sensitive structures within components can be damaged or destroyed. Those who wish to counteract this problem must take various aspects into account: ESD-safe workstations where

electrostatic discharge is safely channelled to earth, electrostatically discharging shoes, workwear and an ESD armband with spiral cable that discharges voltage softly and safely via a large resistance (approx. 1 Meg-Ohm) from the operator to earth. A further precondition is that the tools used are also electrostatically safe.

Wiha's ESD tools are equipped with electrostatically discharging (dissipative) handles that have a defined surface resistance of $10^6 - 10^9$ Ohm. That guarantees "soft discharging" within a set period of time and in a controlled and safe manner, so that sensitive components cannot be damaged. Wiha ESD tools are in accordance with the ESD standard IEC 61340-5-1.

Safety note:
Wiha ESD tools are non-insulating, and are therefore not suitable for work on live parts.

Our large ESD product range makes it easy for you to find the right tool for your ESD applications:

- SoftFinish® ESD screwdrivers
- Precision ESD screwdrivers
- Ceramic tuning and adjusting screwdrivers
- SYSTEM 6 ESD 6 mm interchangeable blades range
- SYSTEM 4 ESD 4 mm interchangeable blades range
- Torque ESD torque screwdrivers
- ESD bit holders
- ESD pliers
- ESD electronics tweezers
- ESD dial gauge vernier callipers



Wiha SoftFinish® ESD.

For use on electrostatically sensitive components.



Wiha SoftFinish® ESD screwdrivers have a surface resistance of $10^6 - 10^9$ ohms.



The SoftFinish® ESD screwdrivers feature an impressive and ergonomic multi-component handle.

For work on electrostatically sensitive devices and assemblies, there is no better screwdriver than the Wiha SoftFinish® ESD, with integrated soft zone in the multi-component handle. The dissipative handle with a surface resistance of $10^6 - 10^9$ ohms discharges the electrostatic energy in a controlled manner to protect devices at risk from electrostatic discharge.

The ergonomic handle form was developed from the basis of extensive scientific investigations in cooperation with the Fraunhofer Institute. The result is a multi-component handle with a seamless outer form. Each hand size adapts perfectly to screwdriver, there are no pressure points while working and loading of the finger joints is minimised.



The hard handle core consists of impact resistant polypropylene. The thermoplastic elastomer handle provides for a pleasant, safe and slip-proof grip. The inseparable handle is connected to the core by a moulding process. The high-quality blade of chromevanadium-molybdenum steel is through hardened and mattechrome plated. The Wiha ChromTop® blade tip ensures a perfect fit in every screw head.

Wiha SoftFinish® ESD screwdrivers correspond to the internationally specified ESD standards IEC61340-5-1.

Safety Notice:
Wiha ESD screwdrivers are non-insulated, therefore not suitable for working on live parts.



Wiha SoftFinish® ESD.

- Dissipative handle designed to discharge uniformly, surface resistance $10^6 - 10^9$ ohms
- Meets ESD standard IEC 61340-5-1
- Ergonomic SoftFinish® multicomponent handle guarantees comfortable work and optimised handling
- Blade made of high-quality CVM steel, through hardened and chrome plated
- Wiha ChromTop® blade tip ensure a perfect fit in every screw head

For slotted, Phillips and Pozidriv screws.



302ESD SoftFinish® ESD slotted screwdriver. Dissipative handle, ESD-safe.

Blade: High quality chrome-vanadium-molybdenum steel, through hardened, chrome-plated.
Wiha ChromTop® finish on tip for a perfect fit every time.

Handle: Ergonomic Wiha SoftFinish® multi-component handle with roll-off protection. Surface resistance $10^6 - 10^9$ ohms.

Standards: IEC 61340-5-1.

Application: For working on electrostatically sensitive components.

Order-No.	⌀	→	⊖	●	→	→	→
08179 9	2.5	75	0.4	2.5	179	23	10
27150 3	3.0	100	0.4	3.0	204	23	10
27151 0	4.0	100	0.8	4.0	211	30	10
08182 9	5.5	125	1.0	5.5	236	30	10
08183 6	6.5	150	1.2	6.0	268	36	10

For slotted, Phillips and Pozidriv screws.



302ESD SoftFinish® ESD slotted screwdriver Stubby. Dissipative handle, ESD-safe.

Blade: High quality chrome-vanadium-molybdenum steel, through hardened, chrome-plated.
Wiha ChromTop® finish on tip for a perfect fit every time.

Handle: Ergonomic Wiha SoftFinish® multi-component handle with roll-off protection. Surface resistance $10^6 - 10^9$ ohms.

Standards: IEC 61340-5-1.

Application: For working on electrostatically sensitive components.

Order-No.	⌀	→	⊖	●	→	→	→
32151 2	4.0	25	0.8	4.0	81	34	10
32152 9	5.5	25	1.0	5.5	81	34	10
32153 6	6.5	25	1.2	6.5	81	34	10



311ESD SoftFinish® ESD Phillips screwdriver. Dissipative handle, ESD-safe.

Blade: High quality chrome-vanadium-molybdenum steel, through hardened, chrome-plated.
Wiha ChromTop® finish on tip for a perfect fit every time.

Handle: Ergonomic Wiha SoftFinish® multi-component handle with roll-off protection. Surface resistance $10^6 - 10^9$ ohms.

Standards: IEC 61340-5-1.

Application: For working on electrostatically sensitive components.

Order-No.	⊕	→	●	→	→	→
08184 3	PH0	60	3.0	164	23	10
08185 0	PH1	80	4.5	191	30	10
08186 7	PH2	100	6.0	218	36	10



311ESD SoftFinish® ESD Phillips screwdriver Stubby. Dissipative handle, ESD-safe.

Blade: High quality chrome-vanadium-molybdenum steel, through hardened, chrome-plated.
Wiha ChromTop® finish on tip for a perfect fit every time.

Handle: Ergonomic Wiha SoftFinish® multi-component handle with roll-off protection. Surface resistance $10^6 - 10^9$ ohms.

Standards: IEC 61340-5-1.

Application: For working on electrostatically sensitive components.

Order-No.	⊕	→	●	→	→	→
32154 3	PH1	25	4.5	81	34	10
32155 0	PH2	25	6.0	81	34	10



313ESD SoftFinish® ESD Pozidriv screwdriver. Dissipative handle, ESD-safe.

Blade: High quality chrome-vanadium-molybdenum steel, through hardened, chrome-plated.
Wiha ChromTop® finish on tip for a perfect fit every time.

Handle: Ergonomic Wiha SoftFinish® multi-component handle with roll-off protection. Surface resistance $10^6 - 10^9$ ohms.

Standards: IEC 61340-5-1.

Application: For working on electrostatically sensitive components.

Order-No.	⊕	→	●	→	→	→
26928 9	PZ0	60	3.0	164	23	10
26929 6	PZ1	80	4.5	191	30	10



313ESD SoftFinish® ESD Pozidriv screwdriver Stubby. Dissipative handle, ESD-safe.

Blade: High quality chrome-vanadium-molybdenum steel, through hardened, chrome-plated.
Wiha ChromTop® finish on tip for a perfect fit every time.

Handle: Ergonomic Wiha SoftFinish® multi-component handle with roll-off protection. Surface resistance $10^6 - 10^9$ ohms.

Standards: IEC 61340-5-1.

Application: For working on electrostatically sensitive components.

Order-No.	⊕	→	●	→	→	→
32156 7	PZ1	25	4.5	81	34	10
32157 4	PZ2	25	6.0	81	34	10



Wiha SoftFinish® ESD.

For use on electrostatically sensitive components.

For TORX® screws. Bit holder.



362ESD SoftFinish® ESD TORX® screwdriver.
Dissipative handle, ESD-safe.

Blade: High quality chrome-vanadium-molybdenum steel, through hardened, chrome-plated.

Wiha ChromTop® finish on tip for a perfect fit every time.

Handle: Ergonomic Wiha SoftFinish® multi-component handle with roll-off protection.
Surface resistance $10^6 - 10^9$ ohms.

Standards: IEC 61340-5-1.

Application: For working on electrostatically sensitive components.

Order-No.	Bit	Length	Width	Depth	Tip
31432 3	T3	60	2.5	164	23
27148 0	T4	60	2.5	164	23
27641 6	T5	60	3.5	164	23
27149 7	T6	60	3.5	164	23
31901 4	T7	60	3.5	164	23
22436 3	T8	60	3.5	164	23
27145 9	T9	60	4.0	171	30
27144 2	T10	80	4.0	191	30
27146 6	T15	80	4.0	191	30
27147 3	T20	100	4.0	218	36



387ESD ESD bit holder with handle, quick release holder, 1/4".
Dissipative handle, ESD-safe.

Handle: Ergonomic Wiha SoftFinish® multi-component handle with roll-off protection.
Surface resistance $10^6 - 10^9$ ohms.

Standards: Handle: IEC 61340-5-1.

Output: For bits according to DIN 3126, ISO1173 style C 6.3, E 6.3 and double bits.

Input: DIN 3126, ISO 1173, style E 6.3.

Bit holder: Stainless steel with retaining ring.

Application: For working on electrostatically sensitive components.

With integrated CentroFix bit holder, suitable for all bits and bit drills with the style C 6.3, E 6.3 or double bits.

Extra: True single-handed operation, extremely high retention force of bits (up to 20 kg) and virtually no play between bit and holder thanks to special closing and holding mechanism.

Order-No.	Bit	Length	Width	Depth	Tip
32161 1	1/4	38	148	30	10

Safety Notice:
Wiha ESD screwdrivers are non-insulated, therefore not suitable for working on live parts.

Sets.



302ESD HK5 01 SoftFinish® ESD slotted/ Phillips screwdriver set, 5 pcs.
Dissipative handle, ESD-safe.

Blade: High quality chrome-vanadium-molybdenum steel, through hardened, chrome-plated.

Wiha ChromTop® finish on tip for a perfect fit every time.

Handle: Ergonomic Wiha SoftFinish® multi-component handle with roll-off protection.
Surface resistance $10^6 - 10^9$ ohms.

Standards: IEC 61340-5-1.

Application: For working on electrostatically sensitive components.

Order-No.	Series	Length	Width	Depth	Tip
27252 4	302ESD HK5 01				1
⊖	302ESD	3.0x100	4.0x100		
⊕	311ESD	PH0x60	PH1x80	PH2x100	



362ESD K5 SoftFinish® ESD TORX® screwdriver set, 5 pcs.
Dissipative handle, ESD-safe.

Blade: High quality chrome-vanadium-molybdenum steel, through hardened, chrome-plated.

Wiha ChromTop® finish on tip for a perfect fit every time.

Handle: Ergonomic Wiha SoftFinish® multi-component handle with roll-off protection.
Surface resistance $10^6 - 10^9$ ohms.

Standards: IEC 61340-5-1.

Application: For working on electrostatically sensitive components.

Order-No.	Series	Length	Width	Depth	Tip
27253 1	362ESD K5				1
⊖	362ESD	T6x60	T8x60	T9x60	
		T10x80	T15x80		

Wiha Precision ESD.

The static dissipative precision screwdriver.



EPA

Wiha ESD precision screwdrivers with the successful handle geometry. Due to the surface resistance of $10^6 - 10^9$ ohms, defined electrostatic discharge is guaranteed.



The rotating cap with contact area makes incremental adjustment quick and easy.

Electrostatic discharges are a major problem, since even low voltages can damage sensitive components.

Various factors have to be considered in order to understand the problem. In ESD protection areas, the electrostatic charge is safely conducted to earth. Users have to wear the appropriate ESD footwear or grounded wrist strap. The tools used also have to be electrostatically protected.



The ESD screwdrivers from Wiha conform to the international ESD Standards IEC 61340-5-1. Due to the electrical surface resistance, $10^6 - 10^9$ Ohm, defined electrostatic discharge is guaranteed. Thanks to the rotating cap, incremental adjusting is easy. The large handle end enables powerful tightening and loosening of screws.

The dissipative Precision ESD – for working on electrostatically sensitive components.

Safety Notice:
Wiha ESD screwdrivers are non-insulated, therefore not suitable for working on live parts.

Wiha Precision ESD.

- Dissipative handle designed to discharge uniformly, surface resistance $10^6 - 10^9$ ohms
- Meets ESD standard IEC 61340-5-1
- Rotating cap with large surface for extra fast working
- Large handle end for powerful tightening and loosening screws
- Wiha ChromTop®-finish on tip for a perfect fit every time



Wiha Precision ESD.

The static dissipative precision screwdriver.

For slotted, Phillips and Pozidriv screws.



272 Precision ESD slotted screwdriver.
Dissipative handle, ESD-safe.
Blade: High quality chrome-vanadium-molybdenum steel, through hardened, chrome-plated.
Wiha ChromTop® finish on tip for a perfect fit every time.
Handle: Precision handle with rotating cap, surface resistance 10⁶ - 10⁹ ohms.
Standards: IEC 61340-5-1.
Application: For working on electrostatically sensitive components.

Order-No.	Ø	Length	Tip	Tip	Tip	Tip
07634 4	1.5	40	0.25	2.0	120	12.5
07635 1	2.0	40	0.40	2.0	120	12.5
07636 8	2.5	50	0.40	2.5	145	13.0
07637 5	3.0	50	0.50	3.0	145	13.0
07638 2	3.5	60	0.60	3.5	170	14.0
07639 9	4.0	60	0.80	4.0	170	14.0



273 Precision ESD Phillips screwdriver.
Dissipative handle, ESD-safe.
Blade: High quality chrome-vanadium-molybdenum steel, through hardened, chrome-plated.
Wiha ChromTop® finish on tip for a perfect fit every time.
Handle: Precision handle with rotating cap, surface resistance 10⁶ - 10⁹ ohms.
Standards: IEC 61340-5-1.
Application: For working on electrostatically sensitive components.

Order-No.	Tip	Length	Tip	Tip	Tip
28053 6	PH000	40	2.0	120	12.5
07640 5	PH00	40	2.0	120	12.5
07641 2	PH0	50	3.0	145	13.0
07642 9	PH1	60	4.0	170	14.0



274 Precision ESD Pozidriv screwdriver.
Dissipative handle, ESD-safe.
Blade: High quality chrome-vanadium-molybdenum steel, through hardened, chrome-plated.
Wiha ChromTop® finish on tip for a perfect fit every time.
Handle: Precision handle with rotating cap, surface resistance 10⁶ - 10⁹ ohms.
Standards: IEC 61340-5-1.
Application: For working on electrostatically sensitive components.

Order-No.	Tip	Length	Tip	Tip	Tip
07643 6	PZ1	60	4.0	170	14

For hex nuts and hex socket screws.



275 Precision ESD hex screwdriver.
Dissipative handle, ESD-safe.
Blade: High quality chrome-vanadium-molybdenum steel, through hardened, chrome-plated.
Wiha ChromTop® finish on tip for a perfect fit every time.
Handle: Precision handle with rotating cap, surface resistance 10⁶ - 10⁹ ohms.
Standards: IEC 61340-5-1.
Application: For working on electrostatically sensitive components.

Order-No.	Tip	Length	Tip	Tip	Tip
27707 9	0.7	40	120	12.5	10
27708 6	0.9	40	120	12.5	10
07644 3	1.3	40	120	12.5	10
07645 0	1.5	50	145	13.0	10
07646 7	2	50	145	13.0	10
07647 4	2.5	60	170	14.0	10
07648 1	3	60	170	14.0	10
32315 8	4	60	170	14.0	10



276 Precision ESD ball end hex screwdriver.
Dissipative handle, ESD-safe.
Blade: High quality chrome-vanadium-molybdenum steel, through hardened, chrome-plated.
Wiha ChromTop® finish on tip for a perfect fit every time.
Handle: Precision handle with rotating cap, surface resistance 10⁶ - 10⁹ ohms.
Standards: IEC 61340-5-1.
Application: For working on electrostatically sensitive components.
Extra: The ball end enables the user to work at angles up to 25°.

Order-No.	Tip	Length	Tip	Tip	Tip
07649 8	1.5	50	145	13.0	10
07650 4	2	50	145	13.0	10
07651 1	2.5	60	170	14.0	10
07652 8	3	60	170	14.0	10



277 Precision ESD hex nut driver.
Dissipative handle, ESD-safe.
Blade: Chrome-vanadium steel, through hardened, chrome-plated.
Handle: Precision handle with rotating cap, surface resistance 10⁶ - 10⁹ ohms.
Standards: IEC 61340-5-1.
Application: For working on electrostatically sensitive components.

Order-No.	Tip	Length	Tip	Tip	Tip	Tip
32312 7	1.5	60	2.5	-	155	13.0
32313 4	2.0	60	2.9	-	155	13.0
07653 5	2.5	60	4.0	4.0	155	13.0
07654 2	3	60	5.0	5.0	155	13.0
07655 9	3.5	60	5.3	6.0	155	13.0
07656 6	4	60	5.5	6.0	155	13.0
32314 1	4.5	60	6.2	7.0	155	13.0
07657 3	5	60	6.8	7.0	155	13.0
07658 0	5.5	60	7.6	8.0	170	14.0

For TORX® screws.



278 Precision ESD TORX® screwdriver.
Dissipative handle, ESD-safe.
Blade: High quality chrome-vanadium-molybdenum steel, through hardened, chrome-plated.
Wiha ChromTop® finish on tip for a perfect fit every time.
Handle: Precision handle with rotating cap, surface resistance 10⁶ - 10⁹ ohms.
Standards: IEC 61340-5-1.
Application: For working on electrostatically sensitive components.

Order-No.	Tip	Length	Tip	Tip	Tip	Tip
25676 0	T1	40	2.5	120	12.5	NEW 10
25677 7	T2	40	2.5	120	12.5	NEW 10
21256 8	T3	40	2.5	120	12.5	10
21255 1	T4	40	2.5	120	12.5	10
07659 7	T5	40	2.5	120	12.5	10
07660 3	T6	40	2.5	120	12.5	10
07661 0	T7	40	2.5	120	12.5	10
07662 7	T8	40	2.5	120	12.5	10
07663 4	T9	50	3.0	145	13.0	10
07664 1	T10	50	3.0	145	13.0	10
07665 8	T15	60	3.5	170	14.0	10
07666 5	T20	60	4.0	170	14.0	10



278R Precision ESD TORX® MagicSpring® screwdriver.
Dissipative handle, ESD-safe.
Retaining spring holds TORX® screws in place.
Blade: High quality chrome-vanadium-molybdenum steel, through hardened, chrome-plated.
Wiha ChromTop® finish on tip for a perfect fit every time.
Handle: Precision handle with rotating cap, surface resistance 10⁶ - 10⁹ ohms.
Standards: IEC 61340-5-1.
Application: For working on electrostatically sensitive components.

Order-No.	Tip	Length	Tip	Tip	Tip	Tip
27748 2	T6	40	2.5	120	12.5	10
27749 9	T7	40	2.5	120	12.5	10
27759 8	T8	40	2.5	120	12.5	10
27750 5	T9	50	3.0	145	13.0	10
27751 2	T10	50	3.0	145	13.0	10
27752 9	T15	60	3.5	170	14.0	10

For TORX PLUS® screws. Chip lifter.



278IP Precision ESD TORX PLUS® screwdriver.
Dissipative handle, ESD-safe.
Blade: High quality chrome-vanadium-molybdenum steel, through hardened, chrome-plated.
Wiha ChromTop® finish on tip for a perfect fit every time.
Handle: Precision handle with rotating cap, surface resistance 10⁶ - 10⁹ ohms.
Standards: IEC 61340-5-1.
Application: For working on electrostatically sensitive components.

Order-No.	Tip	Length	Tip	Tip	Tip	Tip
28198 4	4IP	40	2.5	120	12.5	10
27761 1	5IP	40	2.5	120	12.5	10
27762 8	6IP	40	2.5	120	12.5	10
27763 5	7IP	40	2.5	120	12.5	10
27764 2	8IP	40	2.5	120	12.5	10
27765 9	9IP	50	3.0	145	13.0	10
27766 6	10IP	50	3.0	145	13.0	10
27767 3	15IP	60	3.5	170	14.0	10



279-10 Precision ESD chip lifter.
Dissipative handle, ESD-safe.
Blade: High quality chrome-vanadium-molybdenum steel, through hardened, chrome-plated.
Handle: Precision handle, surface resistance 10⁶ - 10⁹ ohms.
Standards: IEC 61340-5-1.
Application: For lifting tight parts on circuit boards.

Order-No.	Tip	Length	Tip	Tip	Tip
07667 2	3.5	50	145	13.0	10

Wiha Info



Wiha MagicSpring®:
stainless steel spring
reliably holds TORX® or
TORX PLUS® screws in place.



Wiha Precision ESD.

The static dissipative precision screwdriver.

ESD screwdriver sets.



272 K6 Precision ESD slotted/ Phillips screwdriver set, 6 pcs.
Dissipative handle, ESD-safe.

Blade: High quality chrome-vanadium-molybdenum steel, through hardened, chrome-plated.
Wiha ChromTop® finish on tip for a perfect fit every time.

Handle: Precision handle with rotating cap, surface resistance $10^6 - 10^9$ ohms.

Standards: IEC 61340-5-1.

Application: For working on electrostatically sensitive components.

Extra: Practical plastic rack with hanging holes.
In plastic box, can be opened and positioned on workbench.

Order-No.	Series					
08463 9	272 K6					1
⊖	272	1.5x40	2.0x40	2.5x50	3.0x50	
⊕	273	PH00x40	PH0x50			

ESD screwdriver sets.



277 K6 Precision ESD hex nut driver set, 6 pcs.
Dissipative handle, ESD-safe.

Blade: Chrome-vanadium steel, through hardened, chrome-plated.

Handle: Precision handle with rotating cap, surface resistance $10^6 - 10^9$ ohms.

Standards: IEC 61340-5-1.

Application: For working on electrostatically sensitive components.

Extra: Practical plastic rack with hanging holes.
In plastic box, can be opened and positioned on workbench.

Order-No.	Series					
32279 3	277 K6					1
⊖	277	2.5x60	3x60	3.5x60	4x60	
		5x60	5.5x60			



275 K6 Precision ESD hex screwdriver set, 6 pcs.
Dissipative handle, ESD-safe.

Blade: High quality chrome-vanadium-molybdenum steel, through hardened, chrome-plated.
Wiha ChromTop® finish on tip for a perfect fit every time.

Handle: Precision handle with rotating cap, surface resistance $10^6 - 10^9$ ohms.

Standards: IEC 61340-5-1.

Application: For working on electrostatically sensitive components.

Extra: Practical plastic rack with hanging holes.
In plastic box, can be opened and positioned on workbench.

Order-No.	Series					
32278 6	275 K6					1
⊖	275	0.9x40	1.3x40	1.5x50	2x50	
		2.5x60	3x60			



278 K6 Precision ESD TORX® screwdriver set, 6 pcs.
Dissipative handle, ESD-safe.

Blade: High quality chrome-vanadium-molybdenum steel, through hardened, chrome-plated.
Wiha ChromTop® finish on tip for a perfect fit every time.

Handle: Precision handle with rotating cap, surface resistance $10^6 - 10^9$ ohms.

Standards: IEC 61340-5-1.

Application: For working on electrostatically sensitive components.

Extra: Practical plastic rack with hanging holes.
In plastic box, can be opened and positioned on workbench.

Order-No.	Series					
26919 7	278 K6					1
⊖	278	T5x40	T6x40	T7x40	T8x40	
		T10x50	T15x60			

Wiha Ceramic.

The non-static adjustment tool for clean rooms.



The Wiha Ceramic precision screwdrivers with blades made of high-tech zirconium ceramic are the perfect tools for all applications in clean rooms and for delicate electrostatic components. In these areas there are high requirements in terms of eddy-current losses.

The ceramic blades and handles are completely antimagnetic and anti-static. This is a fundamental requirement for working with highly

sensitive components, such as capacitors, solenoids and various resistances. The ceramic blades are resistant to mechanical wear, acid corrosion and thermal shock stress. Wiha Ceramic screwdrivers are available with slotted and Phillips tips, as well as in a set.

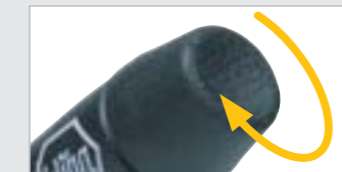

With centring head and quick-turning zone for optimum handling.



The ceramic blade and handle are completely anti-magnetic and anti-static.



Wiha Ceramic.

- Ideal for adjusting electrical components
- Suitable for working in clean rooms
- Anti-static and anti-magnetic handle and blade
- Rotating cap for easy working
- Resistant to mechanical wear, thermal shock stress and acidic corrosion

For slotted and Phillips screws.



270 Ceramic slotted screwdriver.
Non-static adjustment tool with ceramic blade.

Blade: Made of high-quality special ceramic, anti-static/ anti-magnetic.

Handle: Wiha Proturm® Precision handle with rotating cap, anti-static/ anti-magnetic.

Application: Specially designed for tuning and adjusting high frequency devices, suited to cleanrooms.

Order-No.	⊖	⊕	⊖	⊕	⊖	⊕
02163 4	0.9	15	0.35	1.75	94.5	12.5
02164 1	1.3	15	0.35	1.75	94.5	12.5
02167 2	1.8	15	0.35	1.75	94.5	12.5
02168 9	2.6	15	0.35	2.6	94.5	12.5



271 Ceramic Phillips screwdriver.
Non-static adjustment tool with ceramic blade.

Order-No. ⊕

Order-No.	⊕	⊖	⊖	⊕	⊖	⊕
02169 6	PH0	15	2.6	94.5	12.5	10

Ceramic screwdriver set.



270 HK3 Ceramic slotted/ Phillips screwdriver set, 3 pcs.
Non-static adjustment tool with ceramic blade.

Blade: Made of high-quality special ceramic, anti-static/ anti-magnetic.

Handle: Wiha Proturm® Precision handle with rotating cap, anti-static/ anti-magnetic.

Application: Specially designed for tuning and adjusting high frequency devices, suited to cleanrooms.

Extra: Delivered in practical plastic box.

Order-No.	Series			
02171 9	270 HK3			1
⊖	270	0.9x15	2.6x15	
⊕	271	PH0x15		



Wiha SYSTEM 6 ESD.

The compact allrounder.



Colour-coded ChromTop® tips for maximum clarity.

Are you looking for a versatile and space-saving system for your toolbox or for on the road? Then our **SYSTEM 6** exchange tools with 6 mm reversible blades and suitable handles are exactly the right solution for you.

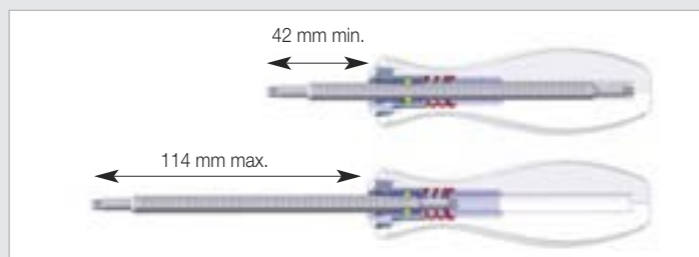

With the SoftFinish® telescopic handle, the blade length can be adjusted from 42 – 114 mm.

Safety Notice:
Wiha ESD screwdrivers are non-insulated, therefore not suitable for working on live parts.

Wiha SYSTEM 6 ESD.

- Flexible, versatile reversible-blade system in industrial quality
- Dissipative handle designed to discharge uniformly, surface resistance $10^6 - 10^9$ ohms
- Meets ESD standard IEC 61340-5-1
- Ergonomic SoftFinish® multicomponent handle guarantees comfortable work and optimised handling
- Colour-coded blades made of high-quality, tough chrome-vanadium-molybdenum steel, through-hardened, chrome-plated
- Wiha ChromTop® tips ensure a perfect fit every time

SYSTEM 6 ESD handle. SYSTEM 6 reversible blades.



284ESD SYSTEM 6 SoftFinish®-telescopic ESD handle. Dissipative handle, ESD-safe.

Handle: Ergonomic multi-component handle with roll-off protection. With 6 mm hex retainer. Enables adjustable blade lengths from 42 - 114 mm. ClickStop ball clamp guarantees a secure hold and rapid blade exchange. Surface resistance $10^6 - 10^9$ ohms.

Standards: IEC 61340-5-1.

Application: For working on electrostatically sensitive components.

Order-No.	⊕	⊕	⊕	⊕	⊕
31496 5	6.0	115	36		5



284 SYSTEM 6 slotted reversible blade.

Blade: High quality chrome-vanadium-molybdenum steel, through hardened, chrome-plated. Colour-coded Wiha ChromTop® tips.

Order-No.	⊕	⊕	⊕	⊕	⊕	⊕	⊕
27627 0	3.5	4.5	0.6	0.8	150	6.0	5
00629 7	4.0	6.0	0.8	1.0	150	6.0	5
00630 3	5.5	6.5	1.0	1.2	150	6.0	5



284 SYSTEM 6 combined slotted-Phillips reversible blade.

Blade: High quality chrome-vanadium-molybdenum steel, through hardened, chrome-plated. Colour-coded Wiha ChromTop® tips.

Order-No.	⊕	⊕	⊕	⊕	⊕	⊕	⊕
00665 5	4.0	PH1	0.8	150	6.0		5
00666 2	6.0	PH2	1.0	150	6.0		5
00667 9	6.5	PH3	1.2	150	6.0		5



284 SYSTEM 6 Phillips reversible blade.

Blade: High quality chrome-vanadium-molybdenum steel, through hardened, chrome-plated. Colour-coded Wiha ChromTop® tips.

Order-No.	⊕	⊕	⊕	⊕	⊕
00631 0	PH1	PH2	150	6.0	5
27628 7	PH2	PH3	150	6.0	5

SYSTEM 6 reversible blades.



284 SYSTEM 6 Pozidriv reversible blade.

Blade: High quality chrome-vanadium-molybdenum steel, through hardened, chrome-plated. Colour-coded Wiha ChromTop® tips.

Order-No.	⊕	⊕	⊕	⊕	⊕
00632 7	PZ1	PZ2	150	6.0	5
27629 4	PZ2	PZ3	150	6.0	5

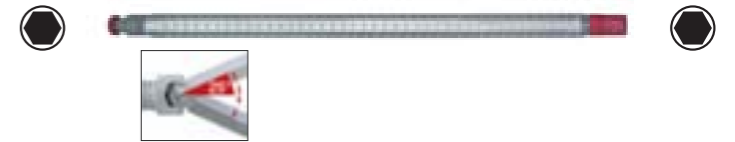

284 SYSTEM 6 combined ball end hex - hex reversible blade.

Blade: High quality chrome-vanadium-molybdenum steel, through hardened, chrome-plated. Colour-coded Wiha ChromTop® tips.

Extra: The ball end enables the user to work at angles up to 25°.

Order-No.	⊕	⊕	⊕	⊕	⊕	⊕
00635 8	2.5	2.5	150	6.0		5
00636 5	3	3	150	6.0		5
00637 2	4	4	150	6.0		5
00638 9	5	5	150	6.0		5
00639 6	6	6	150	6.0		5



284 SYSTEM 6 TORX® reversible blade.

Blade: High quality chrome-vanadium-molybdenum steel, through hardened, chrome-plated. Colour-coded Wiha ChromTop® tips.

Order-No.	⊕	⊕	⊕	⊕	⊕	⊕
00654 9	T6	T8	150	6.0		5
00655 6	T7	T9	150	6.0		5
00656 3	T10	T15	150	6.0		5
00657 0	T20	T25	150	6.0		5
00658 7	T30	T40	150	6.0		5



284 SYSTEM 6 TORX® Tamper Resistant reversible blade.

For TORX® screws with locking pin.

Blade: High quality chrome-vanadium-molybdenum steel, through hardened, chrome-plated. Colour-coded Wiha ChromTop® tips. With borehole in the blade tip.

Order-No.	⊕	⊕	⊕	⊕	⊕	⊕
27630 0	T6H	T8H	150	6.0		5
27631 7	T7H	T9H	150	6.0		5
27632 4	T10H	T15H	150	6.0		5
27633 1	T20H	T25H	150	6.0		5
27634 8	T30H	T40H	150	6.0		5



Wiha SYSTEM 6 ESD.

The compact allrounder.

SYSTEM 6 reversible blades.



284 SYSTEM 6 Tri-Wing® reversible blade.
For Tri-Wing® security screws.
Blade: High quality chrome-vanadium-molybdenum steel, through hardened, chrome-plated.
Colour-coded Wiha ChromTop® tips.

Order-No.	⊕	⊕	↔	⦿	⦿
27637 9	TW0	TW1	150	6.0	5
27638 6	TW2	TW3	150	6.0	5
27639 3	TW4	TW5	150	6.0	5



284 SYSTEM 6 Torq-Set® reversible blade.
For Torq-Set® security screws.
Blade: High quality chrome-vanadium-molybdenum steel, through hardened, chrome-plated.
Colour-coded Wiha ChromTop® tips.

Order-No.	⊕	⊕	↔	⦿	⦿
27635 5	TS2	TS4	150	6.0	5
27636 2	TS6	TS8	150	6.0	5

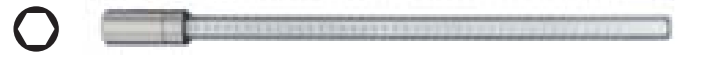

7802 SYSTEM 6 bit holder.
Suitable for C 6.3 and E 6.3 (1/4") bits.
Blade: Chrome-vanadium steel, through hardened, chrome-plated.
Bit retainer made of stainless steel with integrated permanent magnet.

Order-No.	⦿	↔	⦿	⦿	⦿
03882 3	1/4	164	6.0	10	5



7803 SYSTEM 6 adapter blade.
Suitable for 1/4" square sockets.
Blade: Chrome-vanadium steel, through hardened, chrome-plated.
1/4" square drive with ball retainer.

Order-No.	⦿	↔	⦿	⦿	⦿
03883 0	1/4	164	6.0		5



U109 00 SYSTEM 6 extension blade.
Suitable for blades.
Blade: Chrome-vanadium steel, through hardened, chrome-plated.
Extends all SYSTEM 6 blades up to 100 mm.

Order-No.	⦿	↔	⦿	⦿	⦿
08921 4	6.0	166	6.0	11	5

Sets.



284ESD T6 01 SYSTEM 6 ESD set of reversible blades, 6 pcs.
Slotted/ Phillips/ hex/ ball end hex.
Blade: High quality chrome-vanadium-molybdenum steel, through hardened, chrome-plated.
Colour-coded Wiha ChromTop® tips.
Blade length is adjustable from 42 - 114 mm.
Handle: SYSTEM 6 SoftFinish®-telescopic ESD handle.
ESD-safe (dissipative), surface resistance 10⁶ - 10⁹ ohms.
ClickStop ball clamp guarantees a secure hold and rapid blade exchange.
Extra: Robust roll-up bag allows space-saving storage of tools.

Order-No.	Series	⦿
31497 2	284ESD T6 01	1
	284ESD SYSTEM 6 SoftFinish®-telescopic ESD handle	
⦿	⦿ 284	3.5 - 4.5 4.0 - 6.0 5.5 - 6.5
⊕	⊕ 284	PH1 - PH2
⦿	⦿ 284	5 - 5

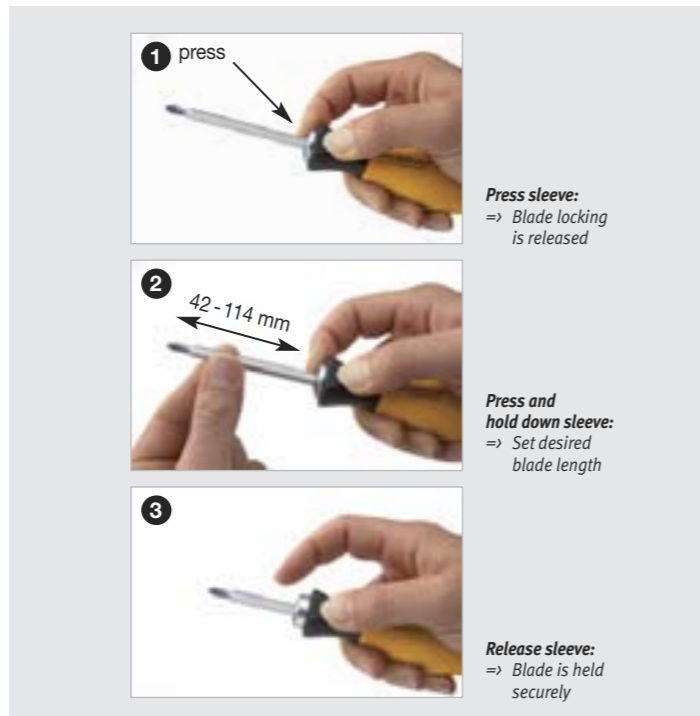

Wiha SYSTEM 4 ESD.

Ideal for precision work.



Colour-coded ChromTop® tips for maximum clarity.

The **SYSTEM 4** from Wiha is an exchange tool system that manages to win over every user with its versatility and quality. Whether for slotted, Phillips, TORX® or hex screws, users always find the right model in the extensive 4 mm blade assortment. All reversible blades are manufactured from high quality chrome-vanadium molybdenum steel, meticulously hardened and chrome-plated. That guarantees an extra long service life.



Convincing variety and quality. SYSTEM 4 – a real multi-tasker.

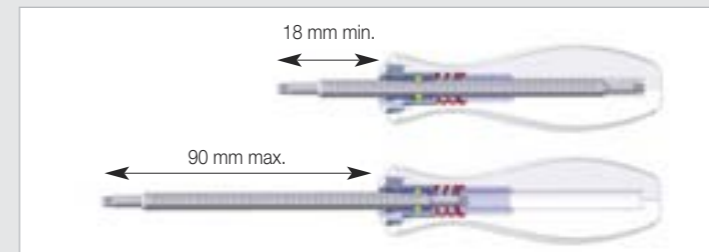

With the SoftFinish® telescopic handle, the blade length can be adjusted from 18 – 90 mm.

Wiha SYSTEM 4 ESD.

- Flexible, versatile reversible precision blade system
- Dissipative handle designed to discharge uniformly, surface resistance 10⁶ - 10⁹ ohms
- Meets ESD standard IEC 61340-5-1
- Ergonomic SoftFinish® multicomponent handle guarantees comfortable work and optimised handling
- Colour-coded blades made of high-quality, tough chrome-vanadium-molybdenum steel, through-hardened, chrome-plated
- Wiha ChromTop® tips ensure a perfect fit every time



Wiha SYSTEM 4 ESD.

Ideal for precision work.

SYSTEM 4 ESD handle and reversible blades.



2691 ESD SYSTEM 4 SoftFinish®-telescopic ESD handle.

Dissipative handle, ESD-safe.
 Handle: Ergonomic multi-component handle with roll-off protection. With 4 mm hex retainer for all SYSTEM 4 blades. Enables adjustable blade lengths from 18 - 90 mm. ClickStop ball clamp guarantees a secure hold and rapid blade exchange. Surface resistance 10⁶ - 10⁹ ohms.
 Standards: IEC 61340-5-1.
 Application: For working on electrostatically sensitive components.

Order-No.	Ø	→	←	⚙️	🔧
31498 9	4.0	105	23		10

SYSTEM 4 ESD reversible blades.



269 SYSTEM 4 Phillips reversible blade.
 Blade: High quality chrome-vanadium-molybdenum steel, through hardened, chrome-plated. Colour-coded Wiha ChromTop® tips.

Order-No.	⊕	⊕	→	⚙️	🔧
00579 5	PH000	PH00	120	4.0	5
00580 1	PH0	PH1	120	4.0	5



269 SYSTEM 4 Pozidriv reversible blade.
 Blade: High quality chrome-vanadium-molybdenum steel, through hardened, chrome-plated. Colour-coded Wiha ChromTop® tips.

Order-No.	⊕	⊕	→	⚙️	🔧
03186 2	PZ0	PZ1	120	4.0	5



269 SYSTEM 4 slotted reversible blade.
 Blade: High quality chrome-vanadium-molybdenum steel, through hardened, chrome-plated. Colour-coded Wiha ChromTop® tips.

Order-No.	⓪	⓪	⊖	⊖	→	⚙️	🔧
00576 4	1.5	3.0	0.25	0.5	120	4.0	5
00577 1	2.0	3.5	0.4	0.6	120	4.0	5
00578 8	2.5	4.0	0.4	0.8	120	4.0	5



269 SYSTEM 4 TORX® reversible blade.
 Blade: High quality chrome-vanadium-molybdenum steel, through hardened, chrome-plated. Colour-coded Wiha ChromTop® tips.

Order-No.	⊛	⊛	→	⚙️	🔧
26122 1	T1	T2	120	4.0	5
26123 8	T3	T4	120	4.0	5
26124 5	T5	T6	120	4.0	5
00597 9	T6	T8	120	4.0	5
00598 6	T7	T9	120	4.0	5
00599 3	T10	T15	120	4.0	5
00600 6	T15	T20	120	4.0	5



269 SYSTEM 4 slotted Phillips reversible blade.
 Blade: High quality chrome-vanadium-molybdenum steel, through hardened, chrome-plated. Colour-coded Wiha ChromTop® tips.

Order-No.	⓪	⊕	⊖	→	⚙️	🔧
00601 3	2.0	PH00	0.4	120	4.0	5
00602 0	3.0	PH0	0.5	120	4.0	5
00603 7	4.0	PH1	0.8	120	4.0	5



269 SYSTEM 4 combined ball end hex - hex reversible blade.
 Blade: High quality chrome-vanadium-molybdenum steel, through hardened, chrome-plated. Colour-coded Wiha ChromTop® tips.
 Extra: The ball end enables the user to work at angles up to 25°.

Order-No.	⓪	⓪	→	⚙️	🔧
00582 5	1.3	1.3	120	4.0	5
00583 2	1.5	1.5	120	4.0	5
00584 9	2	2	120	4.0	5
00585 6	2.5	2.5	120	4.0	5
00586 3	3	3	120	4.0	5
00587 0	4	4	120	4.0	5

SYSTEM 4 bit holder/nut driver blades and set.



U759 00 SYSTEM 4 bit holder.
 Suitable for C 4 (4 mm) bits.
 Blade: Chrome-vanadium steel, through hardened, electro-plated.

Order-No.	⓪	→	⚙️	🔧
09195 8	4.0	135	4.0	9



269 SYSTEM 4 nut driver.
 For hex nuts.
 Blade: High quality chrome-vanadium-molybdenum steel, through hardened, chrome-plated.
 Application: For hex nuts.

Order-No.	⓪	⓪	→	⚙️	🔧
00588 7	1.5	1.8	125	4.0	5
00589 4	2	2.5	125	4.0	5
00590 0	3	-	125	4.0	5
00591 7	3.2	-	125	4.0	5
00592 4	3.5	-	125	4.0	5
00593 1	4	-	125	4.0	5
00594 8	4.5	-	125	4.0	5
00595 5	5	-	125	4.0	5
00596 2	5.5	-	125	4.0	5



2691 T11 ESD SYSTEM 4 ESD reversible blades set, 11 pcs.
 Slotted/ Phillips/ TORX®/ hex/ ball end hex.
 Blade: High quality chrome-vanadium-molybdenum steel, through hardened, chrome-plated. Colour-coded Wiha ChromTop® tips. Blade length is adjustable from 18 - 90 mm.
 Handle: SYSTEM 4 SoftFinish®-telescopic ESD handle. ESD-safe (dissipative), surface resistance 10⁶ - 10⁹ ohms. ClickStop ball clamp guarantees a secure hold and rapid blade exchange.
 Extra: In a roll-up pouch made of ESD-safe material.

Order-No.	Series	🔧
31499 6	2691 T11 ESD	5
	2691 ESD SYSTEM 4 SoftFinish®-telescopic ESD handle	
⓪	⓪ 269	1.5 - 3.0 2.0 - 3.5 2.5 - 4.0
⊕	⊕ 269	PH000 - PH00 PH0 - PH1
⊛	⊛ 269	T6 - T8 T7 - T9
⓪	⓪ 269	1.5 - 1.5 2 - 2 2.5 - 2.5

Sets.



7000 EB16 ESD SYSTEM 4 ESD bit set, 16 pcs.
 Mixed sets.
 Handle: SYSTEM 4 SoftFinish®-telescopic ESD handle. ESD-safe (dissipative), surface resistance 10⁶ - 10⁹ ohms. Enables adjustable bit holder blade length.
 Standards: DIN 3126, ISO 1173, style C 4. IEC 61340-5-1.
 Application: Bit set suitable for smallest screws with electronic components. Flexible working via adjustable blade length and rapid replacement of bit inserts.

Order-No.	Series	🔧
33503 8	7000 EB16 ESD	1
	2691 ESD SYSTEM 4 SoftFinish®-telescopic ESD handle	
	U759 00 SYSTEM 4 bit holder	
⓪	U 750	1x2.0 1x3.0
⊕	U 751	1xPH000 1xPH00 1xPH0 1xPH1
⊛	U 757	1xT3 1xT4 1xT5 1xT6 1xT8
⓪	U 753	1x0.9 1x1.3 1x1.5



7000 EB26 ESD SYSTEM 4 ESD bit set, 26 pcs.
 Mixed sets.
 Handle: SYSTEM 4 SoftFinish®-telescopic ESD handle. ESD-safe (dissipative), surface resistance 10⁶ - 10⁹ ohms. Enables adjustable bit holder blade length.
 Standards: DIN 3126, ISO 1173, style C 4. IEC 61340-5-1.
 Application: Universal set for especially small screws with electronic components. Flexible working via adjustable blade length and rapid replacement of bit inserts.

Order-No.	Series	🔧
33848 0	7000 EB26 ESD	1
	2691 ESD SYSTEM 4 SoftFinish®-telescopic ESD handle	
	U759 00 SYSTEM 4 bit holder	
⓪	U 750	1x1.5 1x2.0 1x3.0 1x4.0
⊕	U 751	1xPH000 1xPH00 1xPH0 1xPH1
⊛	U 757	1xT3 1xT4 1xT5 1xT6 1xT7 1xT8 1xT9 1xT10
⓪	U 753	1x0.7 1x0.9 1x1.3 1x1.5 1x2.0 1x2.5 1x3.0 1x4.0

Safety Notice:
 Wiha ESD screwdrivers are non-insulated, therefore not suitable for working on live parts.



Wiha Torque ESD torque range.



Wiha SoftFinish® ESD screwdrivers have a surface resistance of $10^6 - 10^9$ ohms.



TorqueVario®-S ESD with scale.



2882 TorqueVario®-S ESD torque screwdriver. Torque value can be set via window scale. Automatic release.

Handle: Torque infinitely adjustable with Torque-Setter setting tool (also supplied). Ergonomic multi-component handle, made of ESD-safe dissipative material. Handle sizes proportioned to optimise torque setting. Audible and perceptible click when the pre-set torque has been attained. Surface resistance $10^6 - 10^9$ ohms.

Standards: IEC 61340-5-1. EN ISO 6798, BS EN 26789, ASME B107.14M.

Accuracy: $\pm 6\%$, traceable to national standards (•model 0.1-0.6 Nm = $\pm 10\%$).

Application: For ESD applications where recommended torque settings are important. Use in combination with a Wiha Torque ESD interchangeable blade.

Extra: Delivered in practical plastic box, incl. factory calibration certificate.

Order-No.	Nm	Ø	—	+	—
26865 7	0.1-0.6•	4	127	23	1
26629 5	0.4-1.0	4	127	23	1
26866 4	0.8-2.0	4	131	30	1
30495 9	1.0-5.0	4	138	36	1

• Accuracy $\pm 10\%$

TorqueVario®-S ESD set.



2882 S10 TorqueVario®-S ESD torque screwdriver set, 13 pcs. Torque value can be set via window scale. With bit universal holder and 10 Phillips/ Pozidriv/ TORX®/ hex Standard bits.

Handle: Model 0.8-2.0 Nm. Torque infinitely adjustable with Torque-Setter setting tool (also supplied). Ergonomic multi-component handle, made of ESD-safe dissipative material.

Standards: IEC 61340-5-1. EN ISO 6798, BS EN 26789, ASME B107.14M.

Accuracy: $\pm 6\%$, traceable to national standards.

Application: For ESD applications where recommended torque settings are important.

Extra: Delivered in robust metal box, incl. factory calibration certificate.

Order-No.	Series	—
27687 4	2882 S10	1
	2882	TorqueVario®-S ESD torque screwdriver, Model 0.8-2.0 Nm
	2889	Torque ESD bit universal holder
	288-900	Torque-Setter ESD
⊖	7010 Z	4.0x25 5.5x25
⊕	7011 Z	PH0x25 PH1x25
⊕	7012 Z	PZ0x25 PZ1x25
⊕	7015 Z	T7x25 T8x25 T9x25 T10x25

Wiha TorqueVario®-S ESD with integrated scale.

Specially designed for applications on electrostatic sensitive components and devices that may be damaged by electrostatic fields or discharges. The dissipative handle and blade coating, with a surface resistance of $10^6 - 10^9$ Ohms, controls electrostatic energy discharge. Four models cover torque ranges from 0.1 Nm up to 5.0 Nm.



...in electronic assemblies and ESD protected zones, where electrostatic sensitive components and devices must be grounded, the TorqueVario®-S ESD should be used.

Safety Notice: Wiha ESD screwdrivers are non-insulated, therefore not suitable for working on live parts.



Wiha Torque ESD torque range.

- Dissipative handle designed to discharge uniformly, surface resistance $10^6 - 10^9$ Ohm
- Meets ESD standard IEC 61340-5-1
- Ergonomic SoftFinish® multicomponent handle guarantees comfortable work and optimised handling
- Ergonomic handle sizes that are proportional to the torque ranges
- Each tool is individually tested and marked with an identification number
- Clearly audible and perceptible click on attaining the pre-set torque
- Interchangeable blades are made from high quality-chrome- vanadium steel
- Universal bit holder for all C 6.3 and E 6.3 bits, adapter blade for 1/4" nuts
- Fulfills all accuracy requirements as defined by EN ISO 6789, BS EN 26789 and ASME B 107.14M
- Torque accuracy $\pm 6\%$ of the pre-set scale value
- Delivered with factory calibration certificate



288-900 Torque-Setter ESD. Setting tool for variable Torque ESD screwdrivers. Included in every torque ESD screwdriver delivery.

Blade: Octagonal blade, through hardened, zinc-plated.

Handle: Made of static dissipative plastic material.

Standards: IEC 61340-5-1.

Order-No.	—	—	—
27279 1	80	150	1



Wiha Torque ESD screwdrivers.

Torque ESD interchangeable blades.



2889 Torque ESD slotted interchangeable blade.
For Wiha ESD torque screwdrivers.

Blade: High quality chrome-vanadium-molybdenum steel, through hardened, chrome-plated.
Wiha ChromTop® finish on tip for a perfect fit every time.
Moulded with static dissipative, black plastic material.
Surface resistance $10^6 - 10^9$ ohms.

Standards: IEC 61340-5-1, DIN ISO 2380.
Application: For ESD applications where recommended torque settings are important.

Order-No.	⊖	⊕	⦿	↔	↔	max. Nm	⊖
26869 5	0.25	1.5	4	175	42	0.15	10
26870 1	0.4	2.0	4	175	42	0.4	10
26871 8	0.5	3.0	4	175	42	0.6	10
26872 5	0.6	3.5	4	175	42	1.1	10
26873 2	0.8	4.0	4	175	42	2.5	10



2889 Torque ESD Phillips interchangeable blade.
For Wiha ESD torque screwdrivers.

Blade: High quality chrome-vanadium-molybdenum steel, through hardened, chrome-plated.
Wiha ChromTop® finish on tip for a perfect fit every time.
Moulded with static dissipative, black plastic material.
Surface resistance $10^6 - 10^9$ ohms.

Standards: IEC 61340-5-1, DIN ISO 8764.
Application: For ESD applications where recommended torque settings are important.

Order-No.	⊕	⦿	↔	↔	max. Nm	⊖
26877 0	PH000	4	175	42	0.4	10
26876 3	PH00	4	175	42	0.4	10
26875 6	PH0	4	175	42	0.9	10
26878 7	PH1	4	175	42	3.8	10



2889 Torque ESD Pozidriv interchangeable blade.
For Wiha ESD torque screwdrivers.

Blade: High quality chrome-vanadium-molybdenum steel, through hardened, chrome-plated.
Wiha ChromTop® finish on tip for a perfect fit every time.
Moulded with static dissipative, black plastic material.
Surface resistance $10^6 - 10^9$ ohms.

Standards: IEC 61340-5-1, DIN ISO 8764.
Application: For ESD applications where recommended torque settings are important.

Order-No.	⊕	⦿	↔	↔	max. Nm	⊖
26879 4	PZ0	4	175	42	0.9	10
26880 0	PZ1	4	175	42	3.8	10

Torque ESD interchangeable blades.



2889 Torque ESD TORX® interchangeable blade.
For Wiha ESD torque screwdrivers.

Blade: High quality chrome-vanadium-molybdenum steel, through hardened, chrome-plated.
Wiha ChromTop® finish on tip for a perfect fit every time.
Moulded with static dissipative, black plastic material.
Surface resistance $10^6 - 10^9$ ohms.

Standards: IEC 61340-5-1.
Application: For ESD applications where recommended torque settings are important.
Extra: Very slim blade diameter for hard-to-reach screws.

Order-No.	⦿	⦿	↔	↔	max. Nm	⊖
26881 7	T5	4	175	42	0.4	10
26882 4	T6	4	175	42	0.6	10
26868 8	T7	4	175	42	0.9	10
26883 1	T8	4	175	42	1.3	10
26884 8	T9	4	175	42	2.5	10
26885 5	T10	4	175	42	3.8	10



2889 Torque ESD bit universal holder.
For Wiha ESD torque screwdrivers.
Suitable for C 6.3 and E 6.3 (1/4") bits.

Blade: High quality chrome-vanadium-molybdenum steel, through hardened, chrome-plated. Surface resistance $10^6 - 10^9$ ohms.

Sleeve: Made of stainless steel, moulded with dissipative, black plastic material.
Application: For ESD applications where recommended torque settings are important.

Order-No.	⦿	⦿	↔	↔	⊖
27711 6	1/4	4	162	11	10

Wiha ESD bit holder.



The Wiha ESD bit holder handles have a surface resistance of $10^6 - 10^9$ ohms.



The Wiha SoftFinish® ESD with integrated soft zone is eminently suitable for working with electrostatically endangered construction components in ESD protected zones. The dissipative handles with a surface resistance of $10^6 - 10^9$ ohms conduct electrostatic energy away from endangered electronic components in a controlled and safe way.



Wiha ESD bit holder.

- Dissipative handle designed to discharge uniformly, surface resistance $10^6 - 10^9$ ohms
- Meets ESD standard IEC 61340-5-1
- Ergonomic SoftFinish® multicomponent handle guarantees comfortable work and optimised handling

ESD bit holder with retaining ring.



281-01ESD ESD bit holder with handle, retaining ring, 1/4".
Dissipative handle, ESD-safe.

Handle: Ergonomic Wiha SoftFinish® multi-component handle with roll-off protection. Surface resistance $10^6 - 10^9$ ohms.
Universal use for all bits.

Standards: Handle: IEC 61340-5-1.
Output: For bits according to DIN 3126, ISO1173 style C 6.3.

Bit holder: Stainless steel with retaining ring.
Application: For working on electrostatically sensitive components, especially in tight places.

Order-No.	⦿	↔	↔	⊖
32484 1	1/4	57	34	10

ESD bit holder with quick release holder.



387ESD ESD bit holder with handle, quick release holder, 1/4".
Dissipative handle, ESD-safe.

Handle: Ergonomic Wiha SoftFinish® multi-component handle with roll-off protection. Surface resistance $10^6 - 10^9$ ohms.

Standards: Handle: IEC 61340-5-1.
Output: For bits according to DIN 3126, ISO1173 style C 6.3, E 6.3 and double bits.
Input: DIN 3126, ISO 1173, style E 6.3.

Bit holder: Stainless steel with retaining ring.
Application: For working on electrostatically sensitive components. With integrated CentroFix bit holder, suitable for all bits and bit drills with the style C 6.3, E 6.3 or double bits.

Extra: True single-handed operation, extremely high retention force of bits (up to 20 kg) and virtually no play between bit and holder thanks to special closing and holding mechanism.

Order-No.	⦿	↔	↔	↔	⊖
32161 1	1/4	38	148	30	10



Wiha Professional ESD.

Precise in every detail.



Hard, comfortable elastomer zones ensure low friction in the movement range of the fingers

The anti-static, ergonomic handle is fixed to the pliers

Double leaf spring for sensitive working

Low glare mirror polished finish

Antistatic arms made of soft, non-slip elastomer are gentle on the parts of the hand that are sensitive to pressure

Precision box joint with long service life

Wiha Professional ESD is ideal for electronics professionals needing precise, robust pliers.

The formula for success for the pliers series is as simple as it is clever: uncompromising sharpness and hardness for flush cutting, and pleasant comfort with the handle for firm, fatigue-free grasping, holding and cutting.



The Professional ESD diagonal cutter with a broad, pointed head cut soft wires flush.



The Professional ESD needle-nose pliers are predominantly used for fine gripping and bending work.

Suitable for work at ESD workstations in accordance with IEC 61340-5-1.

Safety Notice:
Wiha Professional ESD pliers are noninsulated, therefore not suitable for working on live parts.



Wiha Professional ESD.

- ESD safe**
Suitable for work at ESD workstations in accordance with IEC 61340-5-1, surface resistance $10^6 - 10^9$ ohms
- Anti-static**
Unique: all handle components are discharging (dissipative)
- Precise**
Box joint, resistant against twisting
- As hard as steel**
Pliers head drop forged from high quality steels
- Robust and durable**
Cutting edges are individually tempered and additionally induction hardened to approx. 64 HRC; joints are extremely wear resistant and withstand high stresses, with high-quality riveting
- Ergonomic**
Extra wide handle backs, with soft and hard zones perfectly distributed across the handle
- Attractive**
Appealing design with finely polished head

Diagonal cutter, narrow, pointed shape.



Z 40 1 04 Diagonal cutter Professional ESD.

Standards: DIN ISO 9654. IEC 61340-5-1.

Head shape: Narrow, pointed head.

Design: Bevelled cutting edges, individually tested, also appropriate for thin, hard wires.

Maximum service life of cutting edge achieved through additional inductive hardening to approx. 64 HRC.

With opening spring. Surface resistance $10^6 - 10^9$ ohms.

Material: High alloy carbon steel C 60.

Application: For cutting different hardnesses of wires in places which are difficult to access.

Order-No.	mm	II	○	○	○	↵	↵
26808 4	115	4 ½	1.0	0.6	0.3	60	5

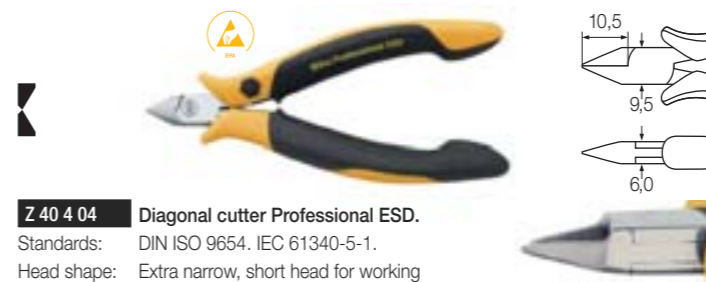

Z 40 4 04 Diagonal cutter Professional ESD.

Standards: DIN ISO 9654. IEC 61340-5-1.

Head shape: Extra narrow, short head for working in particularly restricted spaces.

Design: Cutting edge almost without bevel for virtually flush cutting, individually tested. Maximum service life of cutting edge achieved through additional inductive hardening to approx. 64 HRC.

With opening spring. Surface resistance $10^6 - 10^9$ ohms.

Material: High alloy carbon steel C 60.

Application: For virtually flush cutting copper wire in flat places which are difficult to reach.

Order-No.	mm	II	○	↵	↵
26814 5	115	4 ½	1.0	60	5



Z 40 3 04 Diagonal cutter Professional ESD.

Standards: DIN ISO 9654. IEC 61340-5-1.

Head shape: Narrow, pointed head.

Design: Blade without facet, individually inspected, suited to thin, tough wire.

Maximum service life of cutting edge achieved through additional inductive hardening to approx. 64 HRC.

With opening spring. Surface resistance $10^6 - 10^9$ ohms.

Material: High alloy carbon steel C 60.

Application: For absolutely flush cutting of copper wire in hard-to-reach places.

Order-No.	mm	II	○	↵	↵
33521 2	115	4 ½	1.0	60	5

Diagonal cutter, broad, pointed shape.



Z 41 1 04 Diagonal cutter Professional ESD.

Standards: DIN ISO 9654. IEC 61340-5-1.

Head shape: Wide, pointed head.

Design: Bevelled cutting edges, also appropriate for hard wires.

Maximum service life of cutting edge achieved through additional inductive hardening to approx. 64 HRC.

With opening spring.

Surface resistance $10^6 - 10^9$ ohms.

Material: High alloy carbon steel C 60.

Application: All round electronic diagonal cutter for cutting wires of different hardnesses.

Order-No.	mm	II	○	○	○	↵	↵
26816 9	115	4 ½	1.4	1.0	0.4	60	5

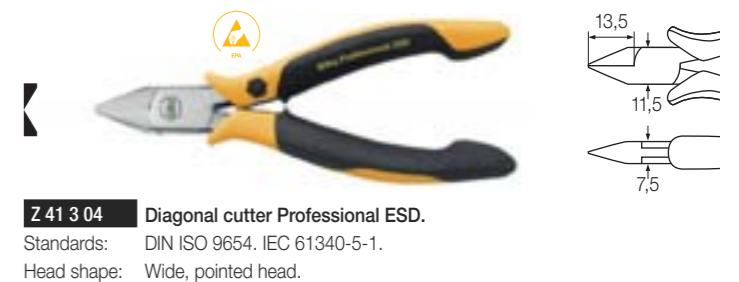

Z 41 3 04 Diagonal cutter Professional ESD.

Standards: DIN ISO 9654. IEC 61340-5-1.

Head shape: Wide, pointed head.

Design: Cutting edge without bevel for absolute flush cutting.

Maximum service life of cutting edge achieved through additional inductive hardening to approx. 64 HRC.

With opening spring. Surface resistance $10^6 - 10^9$ ohms.

Material: High alloy carbon steel C 60.

Application: For absolutely flush cutting of copper wire.

Order-No.	mm	II	○	↵	↵
26821 3	115	4 ½	1.0	60	5



Z 41 4 04 Diagonal cutters Professional ESD with wire trapping spring.

Standards: DIN ISO 9654. IEC 61340-5-1.

Head shape: Wide, pointed head.

Design: With fixture for trapping ends of wires which have been cut off.

Cutting edge with full flush cutter function for virtually flush cutting.

Maximum service life of cutting edge achieved through additional inductive hardening to approx. 64 HRC.

With opening spring. Surface resistance $10^6 - 10^9$ ohms.

Material: High alloy carbon steel C 60.

Application: For virtually flush cutting copper wire, function for trapping cut off wire.

Order-No.	mm	II	○	↵	↵
26822 0	115	4 ½	1.2	60	5



Wiha Professional ESD.

Precise in every detail.

Diagonal cutter, semi-circular shape.



Z 43 1 04 Diagonal cutter Professional ESD.
 Standards: DIN ISO 9654. IEC 61340-5-1.
 Head shape: Narrow, semi-circular head.
 Design: Cutting edge with full flush cutter function for virtually flush cutting. Maximum service life of cutting edge achieved through additional inductive hardening to approx. 64 HRC. With opening spring. Surface resistance $10^6 - 10^9$ ohms.
 Material: High alloy carbon steel C 60.
 Application: For virtually flush cutting of copper wire in places which are difficult to access.

Order-No.	mm	II	○	↺	↻
26826 8	115	4 ½	1.2	60	5



Z 44 1 04 Diagonal cutter Professional ESD.
 Standards: DIN ISO 9654. IEC 61340-5-1.
 Head shape: Wide, semi-circular head.
 Design: Bevelled cutting edges, also appropriate for thin, hard wires. Maximum service life of cutting edge achieved through additional inductive hardening to approx. 64 HRC. With opening spring. Surface resistance $10^6 - 10^9$ ohms.
 Material: High alloy carbon steel C 60.
 Application: All round electronic diagonal cutter for cutting wires of different hardnesses.

Order-No.	mm	II	○	○	○	↺	↻
26831 2	115	4 ½	1.4	1.0	0.4	60	5



Z 44 3 04 Diagonal cutter Professional ESD.
 Standards: DIN ISO 9654. IEC 61340-5-1.
 Head shape: Wide, semi-circular head.
 Design: Cutting edge with full flush cutter function for virtually flush cutting. Maximum service life of cutting edge achieved through additional inductive hardening to approx. 64 HRC. With opening spring. Surface resistance $10^6 - 10^9$ ohms.
 Material: High alloy carbon steel C 60.
 Application: For virtually flush cutting of soft wires.

Order-No.	mm	II	○	↺	↻
26832 9	115	4 ½	1.2	60	5

Oblique end cutters.



Z 46 1 04 Oblique end cutting nippers Professional ESD.
 Standards: DIN ISO 9654. IEC 61340-5-1.
 Head shape: Wide head, angled at 29°.
 Design: Cutting edge with full flush cutter function for virtually flush cutting. Maximum service life of cutting edge achieved through additional inductive hardening to approx. 64 HRC. With opening spring. Surface resistance $10^6 - 10^9$ ohms.
 Material: High alloy carbon steel C 60.
 Application: For virtually flush cutting of soft wires. Can be used horizontally and vertically.

Order-No.	mm	II	○	↺	↻
26835 0	115	4 ½	1.2	78	5



Z 46 4 04 Oblique end cutting nippers Professional ESD.
 Standards: DIN ISO 9654. IEC 61340-5-1.
 Head shape: Extra narrow head. Cutting edges angled at 40°.
 Design: Cutting edge with full flush cutter function for virtually flush cutting. Maximum service life of cutting edge achieved through additional inductive hardening to approx. 64 HRC. With opening spring. Surface resistance $10^6 - 10^9$ ohms.
 Material: High alloy carbon steel C 60.
 Application: For virtually flush cutting thin, soft wires in places which are particularly difficult to access.

Order-No.	mm	II	○	↺	↻
26838 1	110	4 ¼	0.6	42	5



Z 47 1 04 End cutting nippers Professional ESD.
 Standards: DIN ISO 9654. IEC 61340-5-1.
 Head shape: Extra narrow, slim shape.
 Design: Cutting edge with full flush cutter function for virtually flush cutting. Maximum service life of cutting edge achieved through additional inductive hardening to approx. 64 HRC. With opening spring. Surface resistance $10^6 - 10^9$ ohms.
 Material: High alloy carbon steel C 60.
 Application: For virtually flush cutting of soft wires in places which are particularly difficult to access.

Order-No.	mm	II	○	↺	↻
26839 8	110	4 ¼	0.6	65	5

End cutters and gripping pliers.



Z 47 2 04 End cutting nippers Professional ESD.
 Standards: DIN ISO 9654. IEC 61340-5-1.
 Head shape: Wide head.
 Design: Cutting edge with full flush cutter function for virtually flush cutting. Maximum service life of cutting edge achieved through additional inductive hardening to approx. 64 HRC. With opening spring. Surface resistance $10^6 - 10^9$ ohms.
 Material: High alloy carbon steel C 60.
 Application: For frontal, virtually flush cutting of thicker, soft wires.

Order-No.	mm	II	○	↺	↻
26840 4	115	4 ½	1.4	65	5



Z 36 0 04 Needle nose pliers Professional ESD.
 Standards: DIN ISO 9655. IEC 61340-5-1.
 Head shape: Straight head.
 Design: Fine, semi-circular tips. Ridged gripping surfaces. With opening spring. Surface resistance $10^6 - 10^9$ ohms.
 Material: C 45 special tool steel, hardened and tempered.
 Application: Mainly for precision gripping and bending work.

Order-No.	mm	II	A	B	D	F	↺	↻
26799 5	120	4 ¼	9.5	23	6.5	1.4	60	5
27905 9	145	5 ¼	12.0	40	7.5	2.0	93	5



Z 36 1 04 Needle nose pliers Professional ESD.
 Standards: DIN ISO 9655. IEC 61340-5-1.
 Head shape: Angled at 45°.
 Design: Fine, semi-circular tips. Smooth gripping surfaces. With opening spring. Surface resistance $10^6 - 10^9$ ohms.
 Material: C 45 special tool steel, hardened and tempered.
 Application: Mainly for precision gripping and bending work.

Order-No.	mm	II	↺	↻
26802 2	120	4 ¼	60	5

Gripping pliers. Set combinations.



Z 37 0 04 Round nose pliers Professional ESD.
 Standards: DIN ISO 9655. IEC 61340-5-1.
 Head shape: Round, short jaws.
 Design: Smooth gripping surfaces. With opening spring. Surface resistance $10^6 - 10^9$ ohms.
 Material: C 45 special tool steel, hardened and tempered.
 Application: Mainly for precision gripping and bending work.

Order-No.	mm	II	↺	↻
26804 6	120	4 ¼	60	5



Z 38 0 04 Flat nose pliers Professional ESD.
 Standards: DIN ISO 9655. IEC 61340-5-1.
 Head shape: Flat, short jaws.
 Design: Smooth gripping surfaces. With opening spring. Surface resistance $10^6 - 10^9$ ohms.
 Material: C 45 special tool steel, hardened and tempered.
 Application: Mainly for precision gripping and bending work.

Order-No.	mm	II	↺	↻
26806 0	120	4 ¼	60	5



Z 99 0 001 04 Professional ESD pliers set, 4 pcs.
Dissipative tools, electrostatically discharging.
 Design: ESD tools manufactured according to IEC 61340-5-1. All pliers of high quality tool steel, hardened and fine-polished. Plier handles electrostatically discharge via all components. Surface resistance $10^6 - 10^9$ ohms.
 Pouch: Light and space-saving storage of tools.

Content: **Diagonal cutter without facet, 115 mm (Z 41 3 04 series)**
Diagonal cutter with facet, 115 mm (Z 44 1 04 series)
Angular forward cutters, with minimal facet, 110 mm (Z 46 4 04 series)
Electric needle nose pliers, 120 mm (Z 36 0 04 series)

Application: Universal set for all cutting work with electronic applications.

Order-No.	Series	↺	↻
33507 6	Z 99 0 001 04	1	

Wiha Info

A variety of different pliers are required for electronics applications. Simply contact us if you require different models for other applications.



Wiha Professional ESD.

For high standards when it comes to precision and safety.



Depending on the application situation, the tweezers have extra fine, strong or extremely rugged tips

ESD coating

Optimised spring tension and precise symmetry for a firm, secure grasp

Anti-magnetic alloy made of chromium-nickel stainless steel

The new assortment of Wiha electronic tweezers expands the possibilities for exact, and at the same time, careful work with electronic components. These precision, special or universal tweezers are rapidly becoming essential accessories for everyday electronics work due to their high-quality design: ESD safe (anti-static), anti-magnetic, stainless and acid-resistant. Unlike purely metal tweezers, the special coating here ensures a controlled dissipation of static charges, and therefore safe, standard-compliant use.



Thanks to its wide selection of tips, the Professional ESD precision tweezers handle even tricky work effortlessly, for example on sensitive semiconductors.



Tweezers are important tools for any electronics technician to enable the necessary work to be carried out safely in the often small, confined structures of PCBs.

Safety note:
Wiha ESD electronic tweezers are non-insulating, and are therefore not suitable for work on live parts.



Wiha Professional ESD.

- **ESD safe**
Suitable for work at ESD workstations in accordance with IEC 61340-5-1, surface resistance $10^6 - 10^9$ ohms
- **100% anti-magnetic**
High-quality alloy made of chromium-nickel stainless steel with a high nickel content
- **Symmetrical**
Exactly harmonised, precision tips for precise work
- **Acid-resistant and stainless**
For an extra long service life
- **Non-glare surface**
Enables optimal work

Universal tweezers.



ZP 01 0 14 Universal tweezers Professional ESD.

Standards: IEC 61340-5-1.

Design: Smooth gripping surfaces, gripping surfaces without grooves. Non-glare black coated, anti-static. Anti-magnetic and acid-resistant. Surface resistance $10^6 - 10^9$ ohms.

Material: Special alloyed, non-rusting, chromium-nickel stainless steel.

Application: Universal tweezers for all current electronics applications.

Order-No.	mm	Typ	mm	mm
32318 9	130	AA	19	10



ZP 46 0 14 Universal tweezers Professional ESD.

Standards: IEC 61340-5-1.

Design: Fine-tooth gripping surface, grooved gripping surface. Non-glare black coated, anti-static. Anti-magnetic and acid-resistant. Surface resistance $10^6 - 10^9$ ohms.

Material: Special alloyed, non-rusting, chromium-nickel stainless steel.

Application: Universal tweezers for all current electronics applications.

Order-No.	mm	Typ	mm	mm
32343 1	145	40	29	10

Precision tweezers.



ZP 06 0 14 Precision tweezers Professional ESD.

Standards: IEC 61340-5-1.

Design: Smooth gripping surfaces, gripping surfaces without grooves. Non-glare black coated, anti-static. Anti-magnetic and acid-resistant. Surface resistance $10^6 - 10^9$ ohms.

Material: Special alloyed, non-rusting, chromium-nickel stainless steel.

Application: Precision tweezers for gripping and holding electronic components.

Order-No.	mm	Typ	mm	mm
32347 9	130	GG	19	10



ZP 07 1 14 Precision tweezers Professional ESD.

Standards: IEC 61340-5-1.

Design: Smooth gripping surfaces, gripping surfaces without grooves. Non-glare black coated, anti-static. Anti-magnetic and acid-resistant. Surface resistance $10^6 - 10^9$ ohms.

Material: Special alloyed, non-rusting, chromium-nickel stainless steel.

Application: Precision tweezers for gripping and holding electronic components.

Order-No.	mm	Typ	mm	mm
32325 7	130	PSF	18	10



ZP 09 0 14 Precision tweezers Professional ESD.

Standards: IEC 61340-5-1.

Design: Smooth gripping surfaces, gripping surfaces without grooves. Non-glare black coated, anti-static. Anti-magnetic and acid-resistant. Surface resistance $10^6 - 10^9$ ohms.

Material: Special alloyed, non-rusting, chromium-nickel stainless steel.

Application: Precision tweezers for gripping and holding electronic components.

Order-No.	mm	Typ	mm	mm
32326 4	135	SS	13	10



Wiha Professional ESD.

For high standards when it comes to precision and safety.

Precision tweezers.



ZP 11 0 14 Precision tweezers Professional ESD.

Standards: IEC 61340-5-1.
Design: Smooth gripping surfaces, gripping surfaces without grooves.
Non-glare black coated, anti-static.
Anti-magnetic and acid-resistant.
Surface resistance $10^6 - 10^9$ ohms.
Material: Special alloyed, non-rusting, chromium-nickel stainless steel.
Application: Precision tweezers for gripping and holding electronic components.

Order-No.	mm	Typ	↔	↔
32327 1	120	00	21	10



ZP 15 0 14 Precision tweezers Professional ESD.

Standards: IEC 61340-5-1.
Design: Smooth gripping surfaces, gripping surfaces without grooves.
Non-glare black coated, anti-static.
Anti-magnetic and acid-resistant.
Surface resistance $10^6 - 10^9$ ohms.
Material: Special alloyed, non-rusting, chromium-nickel stainless steel.
Application: Precision tweezers for gripping and holding electronic components.

Order-No.	mm	Typ	↔	↔
32329 5	120	2a	16	10



ZP 16 0 14 Precision tweezers Professional ESD.

Standards: IEC 61340-5-1.
Design: Smooth gripping surfaces, gripping surfaces without grooves.
Non-glare black coated, anti-static.
Anti-magnetic and acid-resistant.
Surface resistance $10^6 - 10^9$ ohms.
Material: Special alloyed, non-rusting, chromium-nickel stainless steel.
Application: Precision tweezers for gripping and holding electronic components.

Order-No.	mm	Typ	↔	↔
32346 2	110	3c	14	10

Precision tweezers.



ZP 18 0 14 Precision tweezers Professional ESD.

Standards: IEC 61340-5-1.
Design: Smooth gripping surfaces, gripping surfaces without grooves.
Non-glare black coated, anti-static.
Anti-magnetic and acid-resistant.
Surface resistance $10^6 - 10^9$ ohms.
Material: Special alloyed, non-rusting, chromium-nickel stainless steel.
Application: Precision tweezers for gripping and holding electronic components.

Order-No.	mm	Typ	↔	↔
32334 9	110	5	13	10



ZP 20 1 14 Precision tweezers Professional ESD.

Standards: IEC 61340-5-1.
Design: Smooth gripping surfaces, gripping surfaces without grooves.
Non-glare black coated, anti-static.
Anti-magnetic and acid-resistant.
Surface resistance $10^6 - 10^9$ ohms.
Material: Special alloyed, non-rusting, chromium-nickel stainless steel.
Application: Precision tweezers for gripping and holding electronic components.

Order-No.	mm	Typ	↔	↔
32335 6	120	7a	15	10



ZP 20 2 14 Precision tweezers Professional ESD.

Standards: IEC 61340-5-1.
Design: Smooth gripping surfaces, gripping surfaces without grooves.
Non-glare black coated, anti-static.
Anti-magnetic and acid-resistant.
Surface resistance $10^6 - 10^9$ ohms.
Material: Special alloyed, non-rusting, chromium-nickel stainless steel.
Application: Precision tweezers for gripping and holding electronic components.

Order-No.	mm	Typ	↔	↔
32336 3	120	7abb	15	10

Safety note:
Wiha ESD electronic tweezers
are non-insulating, and are therefore
not suitable for work on live parts.

SMD tweezers.



ZP 24 0 14 SMD tweezers Professional ESD.

Standards: IEC 61340-5-1.
Design: Smooth gripping surfaces, gripping surfaces without grooves.
Non-glare black coated, anti-static.
Anti-magnetic and acid-resistant.
Surface resistance $10^6 - 10^9$ ohms.
Material: Special alloyed, non-rusting, chromium-nickel stainless steel.
Application: SMD special tweezers for horizontal gripping of components.

Order-No.	mm	Typ	↔	↔
32338 7	120	12	15	10



ZP 25 2 14 SMD tweezers Professional ESD.

Standards: IEC 61340-5-1.
Design: Smooth gripping surfaces, gripping surfaces without grooves.
Non-glare black coated, anti-static.
Anti-magnetic and acid-resistant.
Surface resistance $10^6 - 10^9$ ohms.
Material: Special alloyed, non-rusting, chromium-nickel stainless steel.
Application: SMD special tweezers for horizontal gripping of components.

Order-No.	mm	Typ	↔	↔
32340 0	120	13	16	10



ZP 25 3 14 SMD tweezers Professional ESD.

Standards: IEC 61340-5-1.
Design: Smooth gripping surfaces, gripping surfaces without grooves.
Non-glare black coated, anti-static.
Anti-magnetic and acid-resistant.
Surface resistance $10^6 - 10^9$ ohms.
Material: Special alloyed, non-rusting, chromium-nickel stainless steel.
Application: SMD special tweezers for horizontal gripping of components.

Order-No.	mm	Typ	↔	↔
32337 0	120	8b	16	10

SMD tweezers.



ZP 50 0 14 SMD tweezers Professional ESD.

Standards: IEC 61340-5-1.
Design: Smooth gripping surface, grooved gripping surface.
Non-glare black coated, anti-static.
Anti-magnetic and acid-resistant.
Surface resistance $10^6 - 10^9$ ohms.
Material: Special alloyed, non-rusting, chromium-nickel stainless steel.
Application: SMD special tweezers for gripping and holding horizontally-designed components.

Order-No.	mm	Typ	↔	↔
32344 8	117	59	14	10



ZP 99 0 140 02 SMD tweezer set Professional ESD, 4 pcs.

Dissipative tools, electrostatically discharging.
Design: ESD tools manufactured according to IEC 61340-5-1.
All tweezers are ESD-safe (anti-static) via a special ESD coating, acid-resistant, non-rusting and 100% anti-magnetic.
Surface resistance $10^6 - 10^9$ ohms.

Content: **Universal tweezers, pointed, 130 mm (ZP 01 0 14 series)**
Precision tweezers, angular-wide tips, 130 mm (ZP 07 1 14 series)
SMD tweezers, flat gripping surfaces, 120 mm (ZP 25 2 14 series)
SMD tweezers, gripping surface with radius, 117 mm (ZP 50 0 14 series)

Application: Hand assembly of PCBs with SMD components or re-work activities.

Order-No.	Series	↔
32349 3	ZP 99 0 140 02	1

Wiha Info

A variety of different tweezers are required for electronics applications.

Simply contact us if you require different models for other applications.



Wiha dialMax ESD.

Dial calliper.

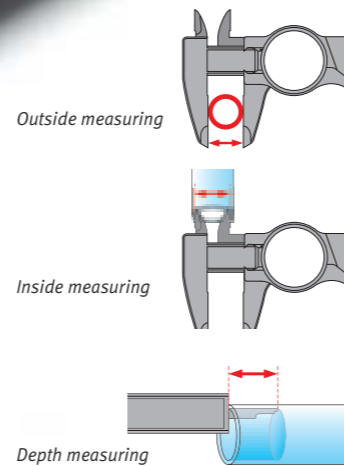

dialMax ESD.



411 210 8 Dial calliper dialMax ESD, reading 0.1 mm.

Material:	Calliper made of ESD-safe material. Surface resistance $10^6 - 10^9$ ohms.
Scale:	Dial, diameter 35 mm.
Reading:	0.1 mm; 1 dial rotation represents 10 mm. Accuracy as per DIN 862.
Packaging:	Blister packed.
Standards:	IEC 61340-5-1.
Application:	For all work with electrostatically endangered components. For outside, inside and depth measurements.
Extra:	Measurements in ESD protection zones and at ESD workstations. Impact resistant dial can be recalibrated to zero.

Order-No.				
31439 2	150	6	45	5

In 1965, new frontiers were entered with the world's first non-metallic callipers, manufactured from high-quality glass-fibre reinforced plastic, with a high level of Swiss precision. Due to the unique advantages made available by the high-tech material, the "max Series" products have found new applications where their advantages are distinct when compared to the more heavy metal designs.



Wiha dialMax ESD.

- Non-metallic high-tech material with 60% fibre-glass content, extremely high rigidity
- Extremely wear-resistant measuring jaw for precise measurements in the long-term
- Non-corrosive, non-magnetic, hardly conductive and electrically insulated
- Resistant to chemicals (alkalis, petrol, oil, grease, etc.)
- Thermal stability of the measuring surfaces: short-term up to 180°C, continuous 100 - 120°C
- Practical ratchet guarantees uniform clamping force of the measuring jaw
- Unlike metal callipers, prevents damage to delicate surfaces
- Electrostatically discharging (dissipative), surface resistance $10^6 - 10^9$ ohms
- Meets ESD standard IEC 61340-5-1

Wiha ESD application sets.

The right tool for any application.

ESD application sets.



9300-015 Wiha operator kit, 5 pcs.

Dissipative tools, electrostatically discharging.
ESD tools manufactured according to IEC 61340-5-1. Maximum protection of electronic components from electrostatically discharging tools and packaging.

Pouch: Handy leather bag, ideal for all overall pockets. Safe storage of tools directly in the overall. No danger of injury to users or damage to workwear from sharp or loose tools in overall pockets.

Content: Professional ESD universal tweezers (ZP 01 0 14 series)

Wiha Precision ESD screwdrivers:
– Slotted screwdriver, 2.5x50 (272 series)
– Phillips screwdriver, PH0x50 (273 series)
SMD belt shears (246 series)
Dust and dirt brush (246 series)

Application: The most important tools for automatic insertion machines in continuous operation.

Order-No.	Series	
33504 5	9300-015	1

ESD application sets.



9300-016 Wiha electronic assembling kit, 9 pcs.

Dissipative tools, electrostatically discharging.
ESD tools manufactured according to IEC 61340-5-1. Diagonal cutters without facet especially suitable for clean and smooth cutting of wired components. Wide selection of current screwdrivers for electronic applications. With universal tweezers for assembly of PCBs or for SMD re-work activities.

Pouch: Robust and space-saving storage of tools.

Content: Diagonal cutter without facet, 115 mm (Z 41 3 04 series)

Electric needle nose pliers, 120 mm (Z 36 0 04 series)
Professional ESD universal tweezers (ZP 01 0 14 series)
Wiha Precision ESD screwdrivers:
– Slotted screwdriver, 2.0x40 / 2.5x50 (272 series)
– Phillips screwdriver, PH00x40 / PH0x50 (273 series)
– TORX® screwdriver, T5x40 / T6x40 (278 series)

Application: The most important tools for hand assembly of electronic components and re-work activities.

Order-No.	Series	
33505 2	9300-016	1



9300-017 Wiha electronic service kit, 8 pcs.

Dissipative tools, electrostatically discharging.
ESD tools manufactured according to IEC 61340-5-1. Diagonal cutters with facet, suitable for cutting of thin and hard wires. Wide selection of current reversible blades for electronic applications. Light and compact design.

Pouch: Light and space-saving storage of tools.

Content: Diagonal cutter with facet, 115 mm (Z 44 1 04 series)

Electric needle nose pliers, 120 mm (Z 36 0 04 series)
Professional ESD universal tweezers (ZP 01 0 14 series)
SYSTEM 4 SoftFinish® telescopic ESD handle
SYSTEM 4 reversible blades (269 series):
– Slotted/ Phillips: 2.0 - PH00 / 2.5 - PH0
– TORX®: T5-T6
– Hexagon/hexagon ball end: SW 1.5 - SW 1.5

Application: Set combination ideally suited to maintenance work with electronic components.

Order-No.	Series	
33506 9	9300-017	1

Wiha Info

Wiha application sets:

- Tool sets especially matched to your application
- Orderly, clearly laid out arrangement of the most common tools
- No additional ballast due to unnecessary tools
- Direct input of the experience of final users already integrated in product development